

# SIGMA

## SIGMA 20mm T1.5 FF Dimensions EF Mount

### Spur gear specifications

	Focus drive gear	Iris drive gear
Number of teeth	128	120
Module	0.8	0.8
P.C.D	102.4mm	96mm
Angular rotation	180°	60°

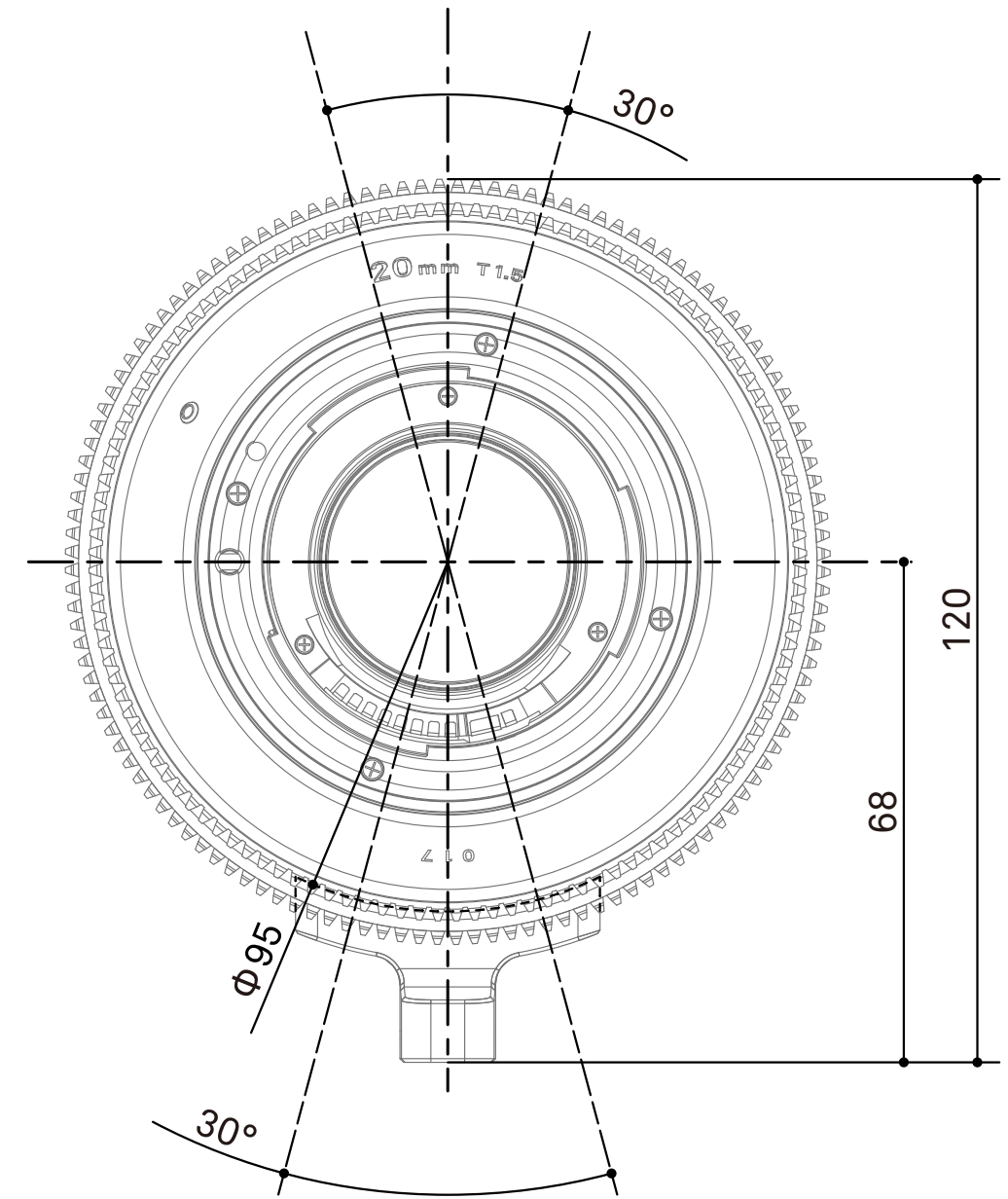
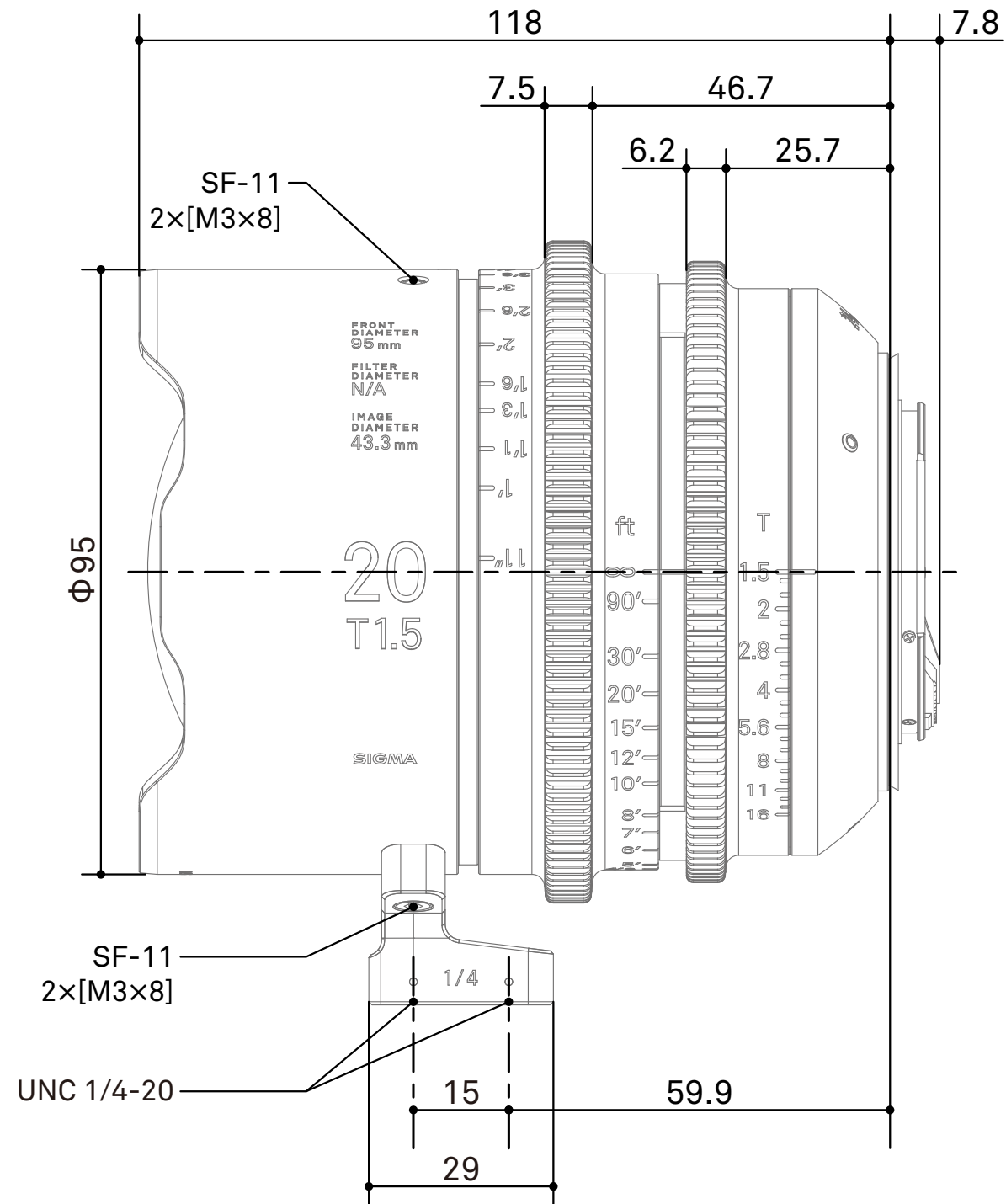

/mm  
scale 1:1

# SIGMA

## SIGMA 20mm T1.5 FF Dimensions E Mount

### Spur gear specifications

	Focus drive gear	Iris drive gear
Number of teeth	128	120
Module	0.8	0.8
P.C.D	102.4mm	96mm
Angular rotation	180°	60°

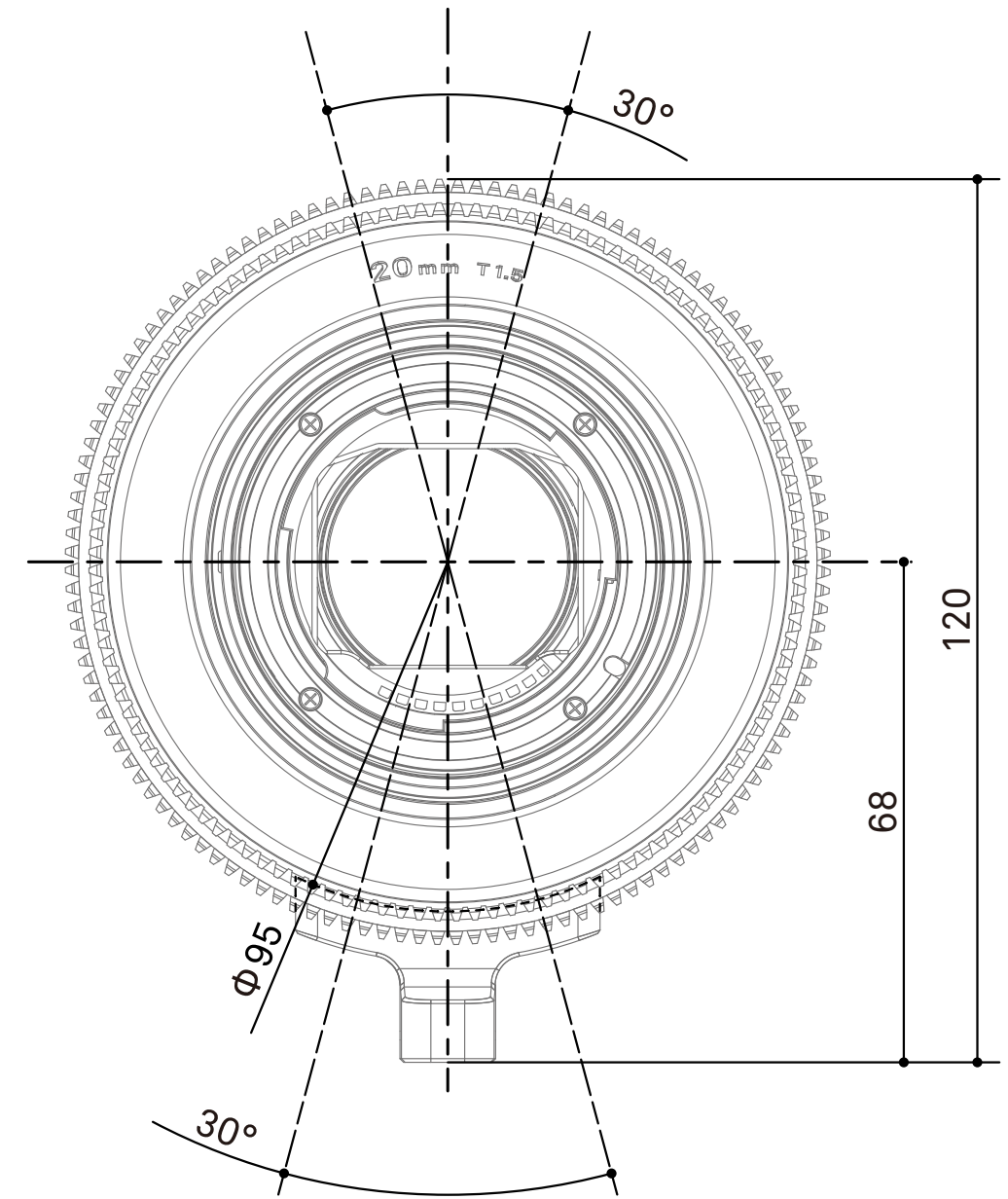
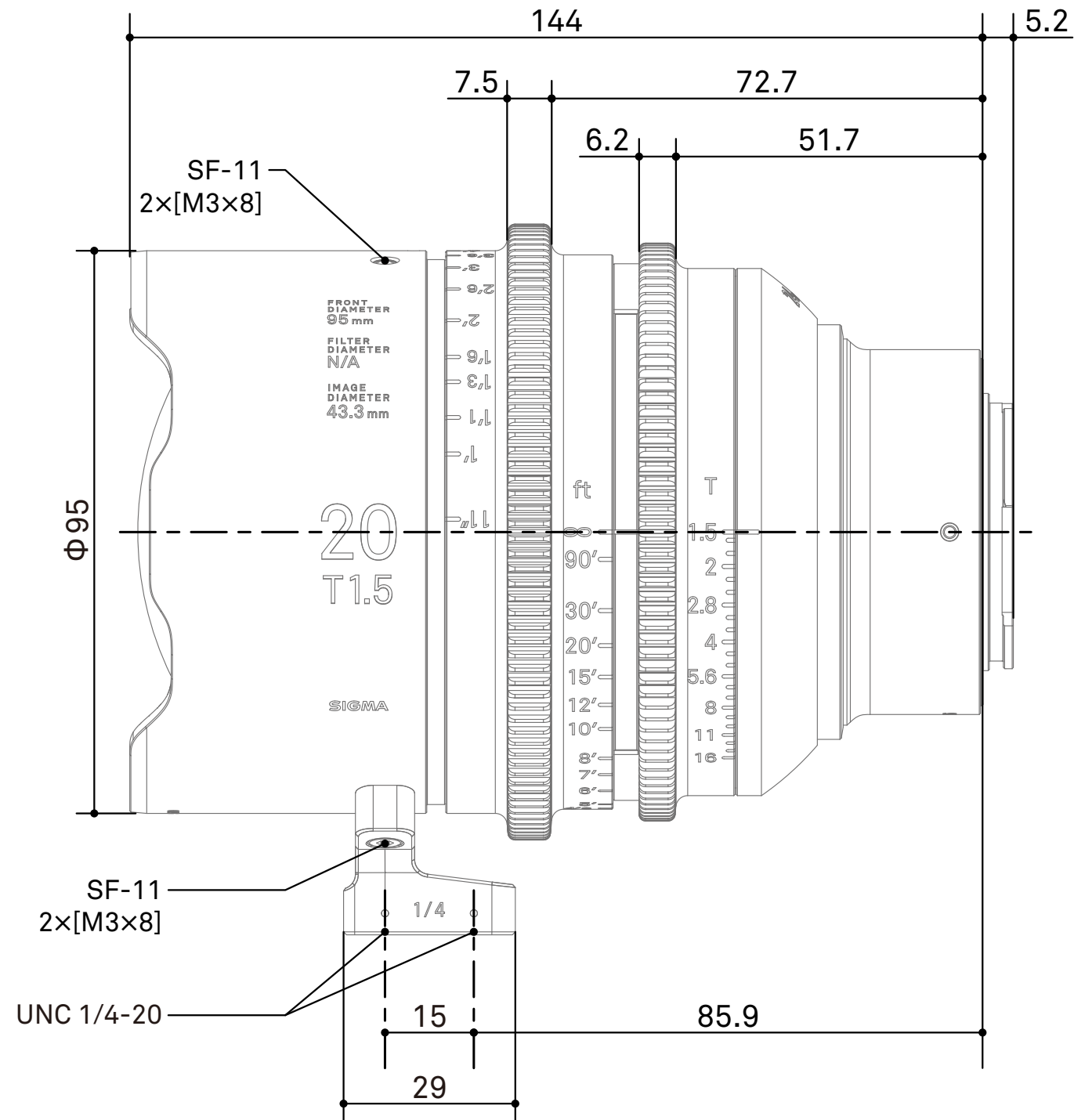

/mm  
scale 1:1

# SIGMA

## SIGMA 20mm T1.5 FF Dimensions PL Mount

Spur gear specifications

	Focus drive gear	Iris drive gear
Number of teeth	128	120
Module	0.8	0.8
P.C.D	102.4mm	96mm
Angular rotation	180°	60°

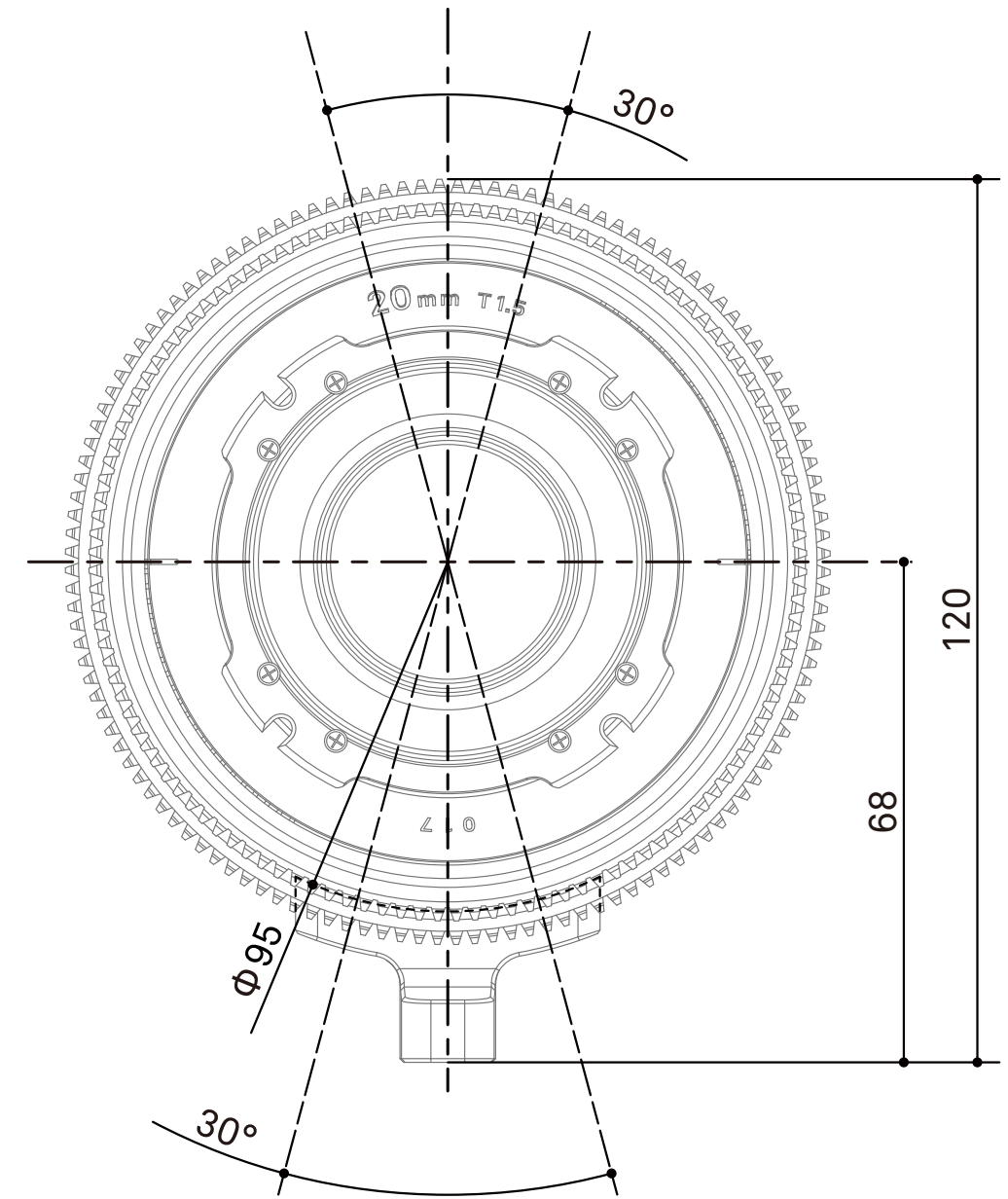
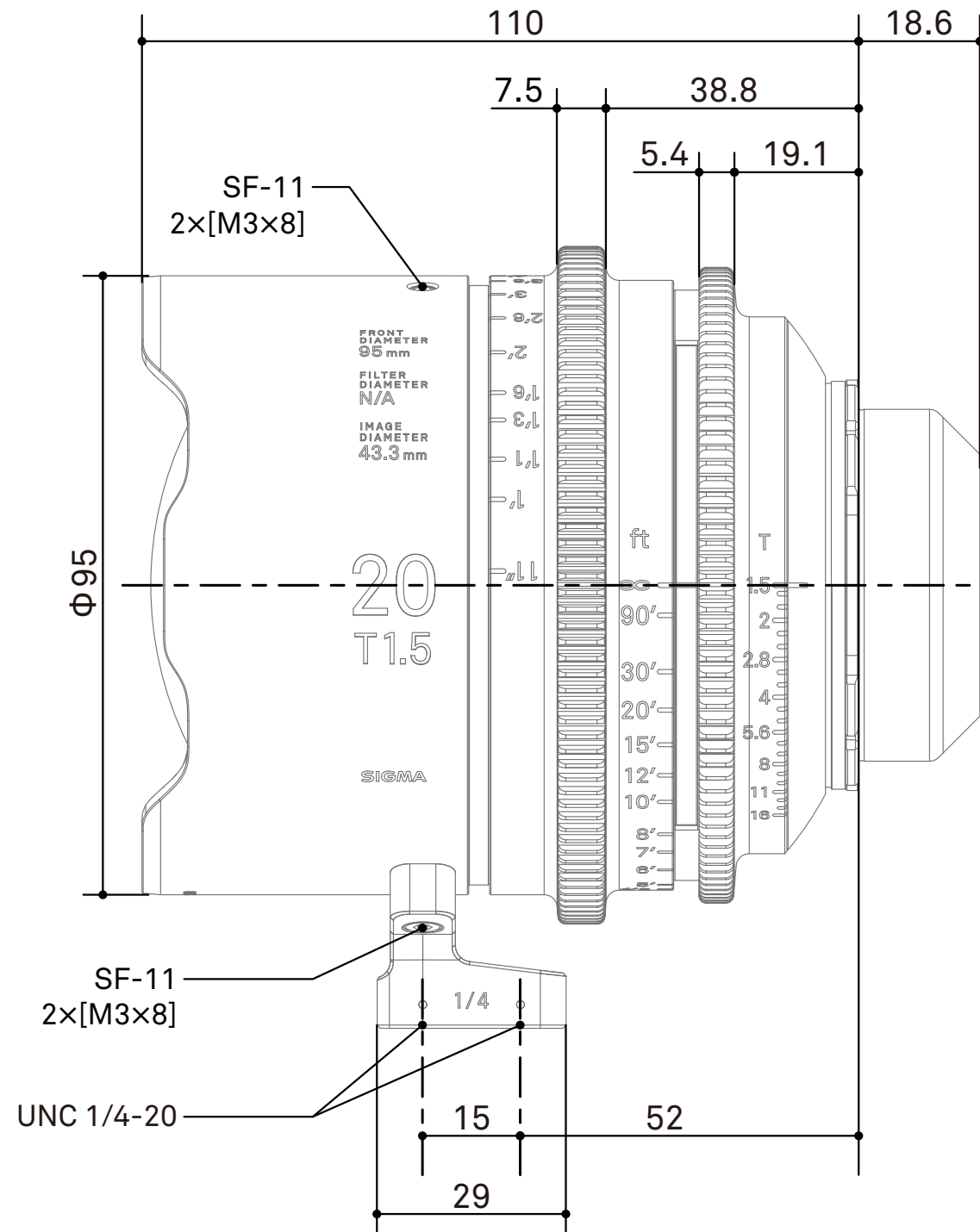

/mm  
scale 1:1