

SIGMA

SIGMA 24mm T1.5 FF Dimensions EF Mount

Spur gear specifications

	Focus drive gear	Iris drive gear
Number of teeth	128	120
Module	0.8	0.8
P.C.D	102.4mm	96mm
Angular rotation	180°	60°

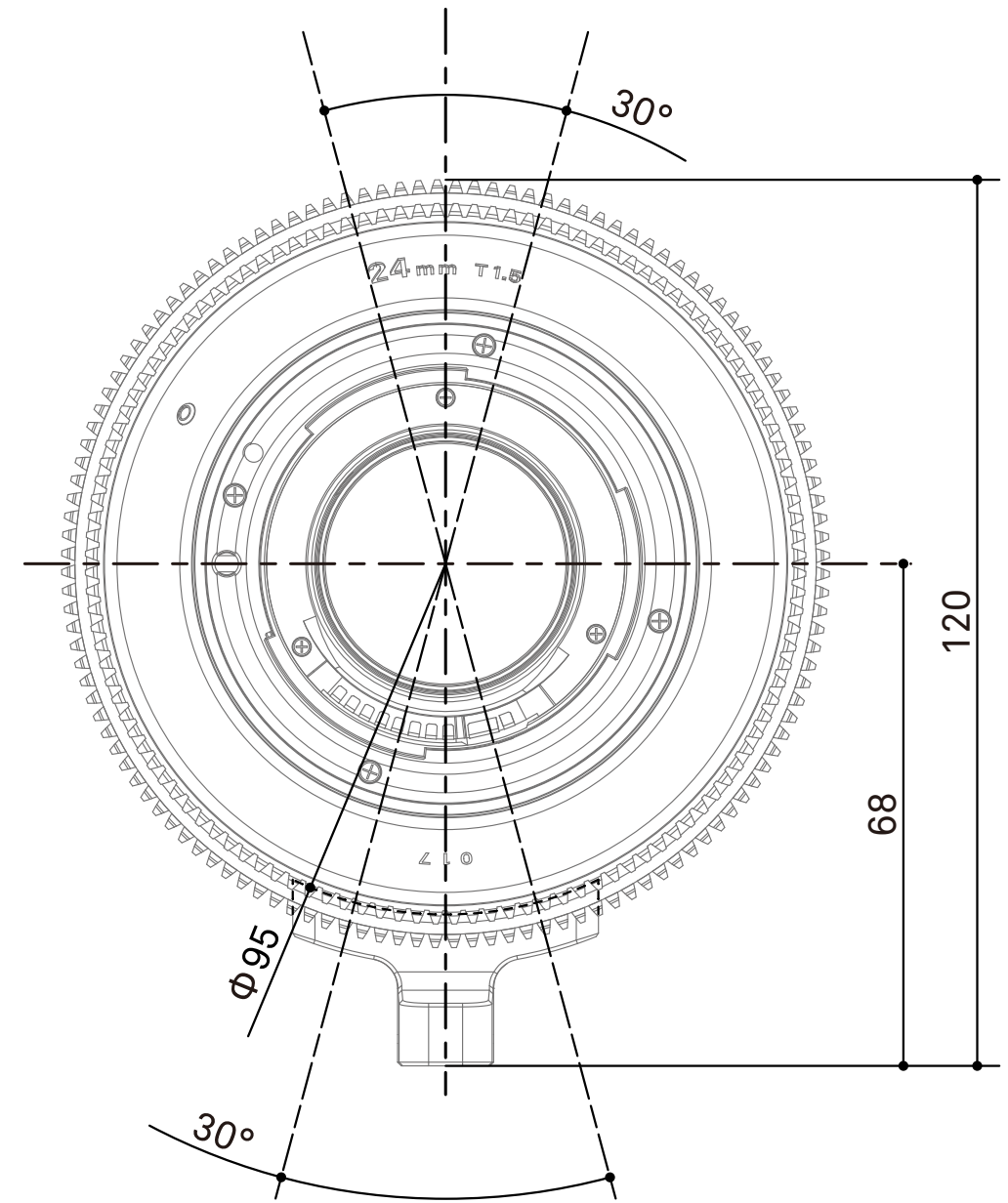
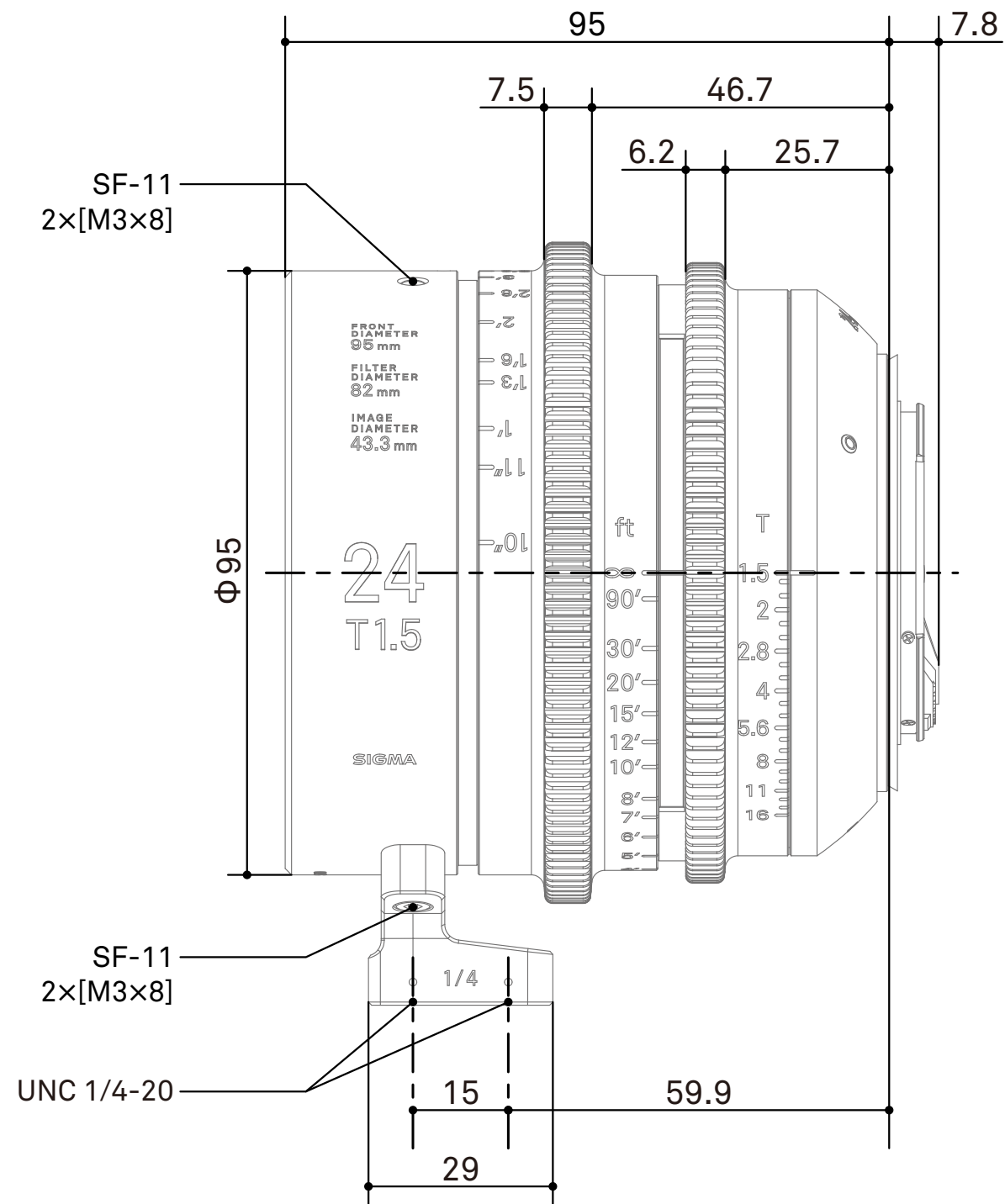

/mm
scale 1:1

SIGMA

SIGMA 24mm T1.5 FF Dimensions E Mount

Spur gear specifications

	Focus drive gear	Iris drive gear
Number of teeth	128	120
Module	0.8	0.8
P.C.D	102.4mm	96mm
Angular rotation	180°	60°

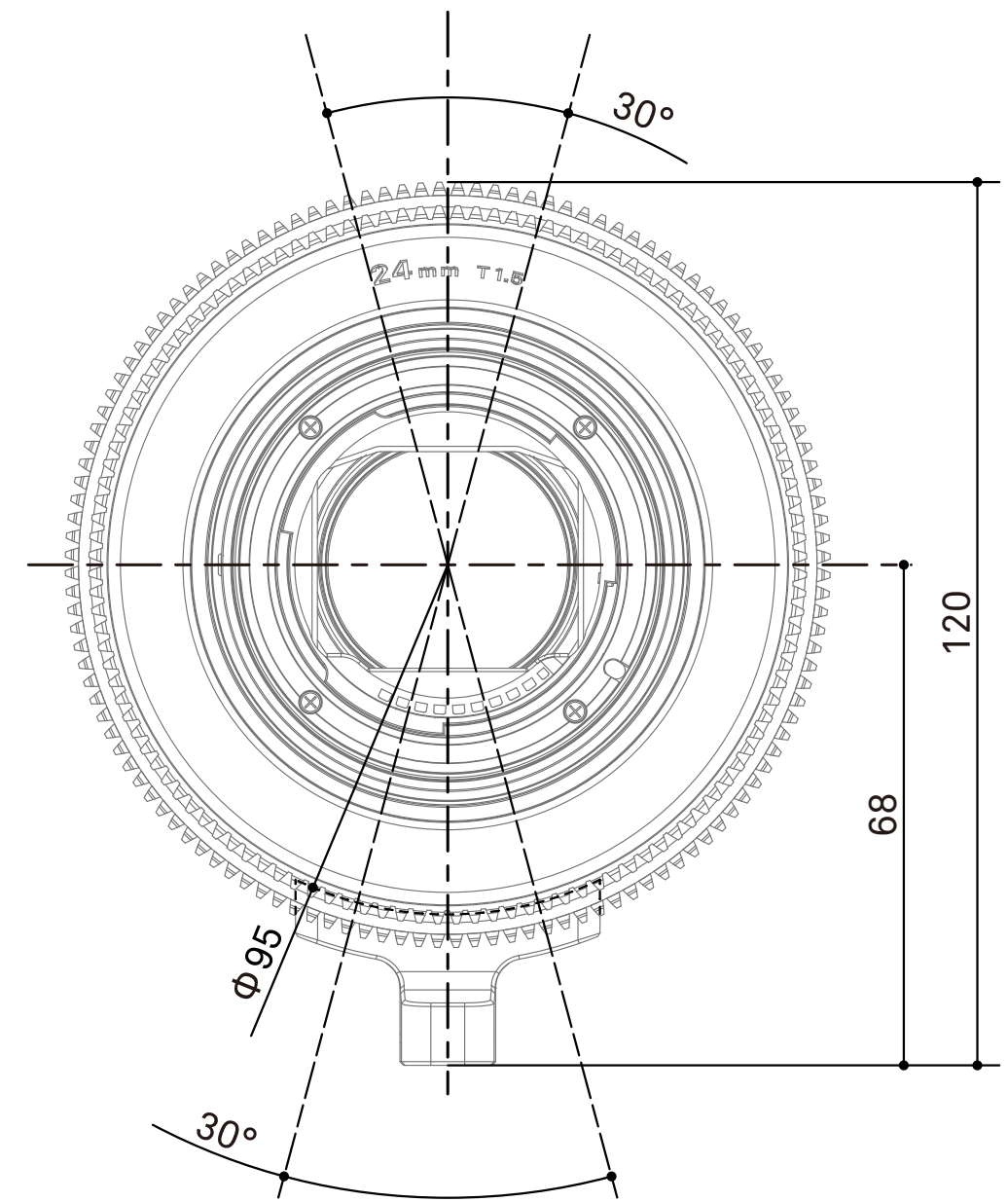
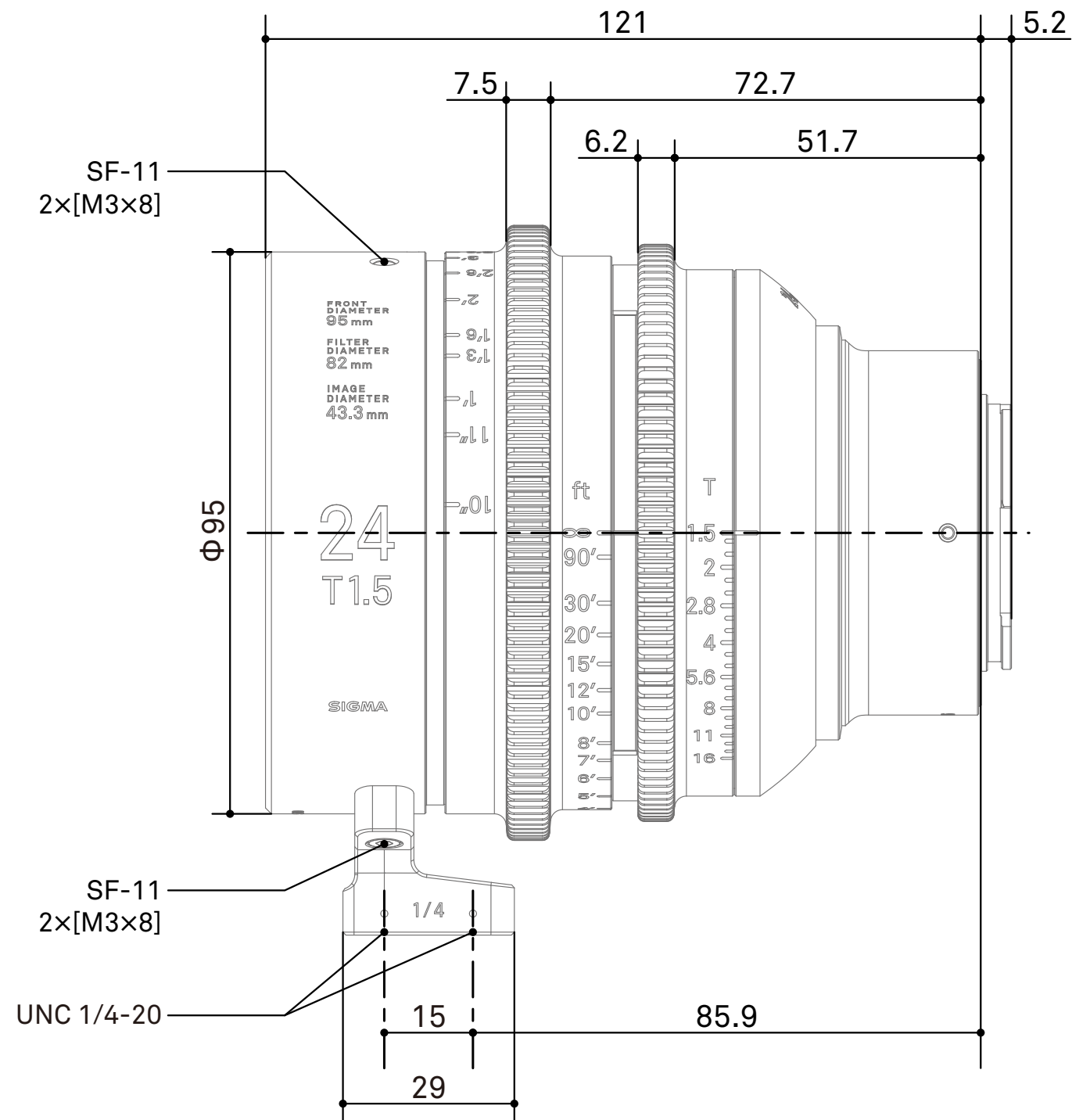

/mm
scale 1:1

SIGMA

SIGMA 24mm T1.5 FF Dimensions PL Mount

Spur gear specifications

	Focus drive gear	Iris drive gear
Number of teeth	128	120
Module	0.8	0.8
P.C.D	102.4mm	96mm
Angular rotation	180°	60°

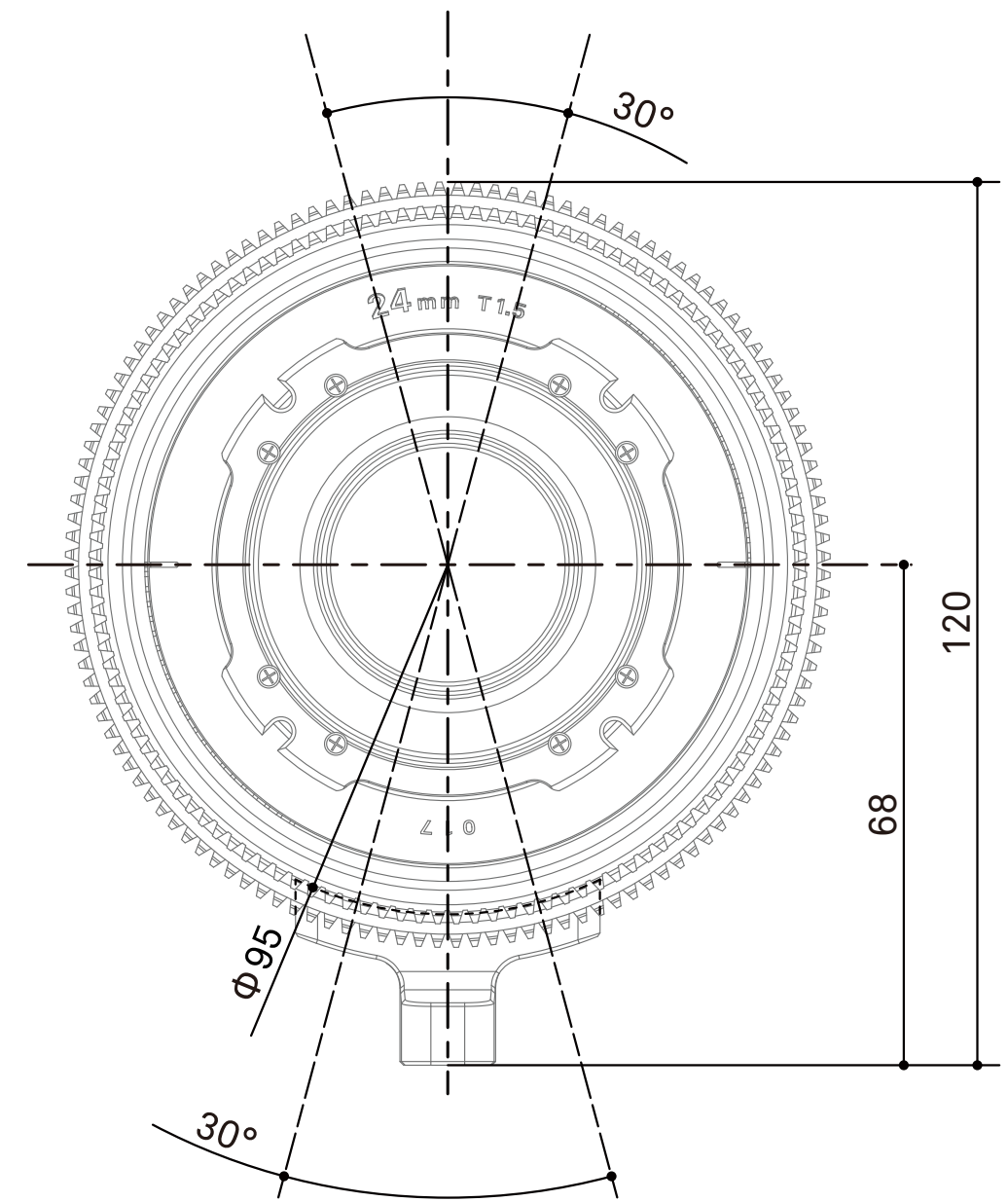
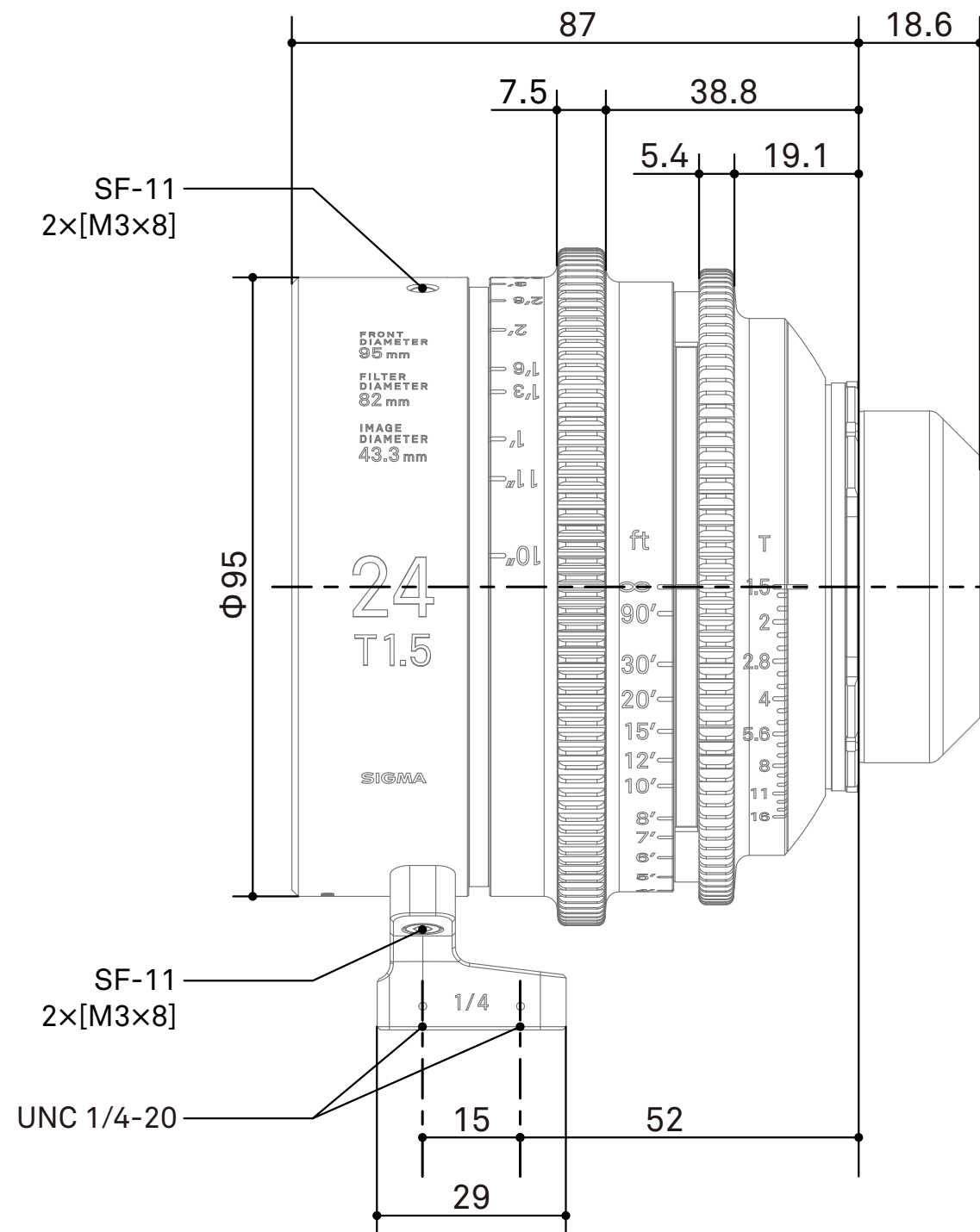

/mm
scale 1:1